

Article number: 20990ALD15500EL

Description: E+G GN 990 Construction tube round  
GN 990-AL-D15-500-EL

## Measures

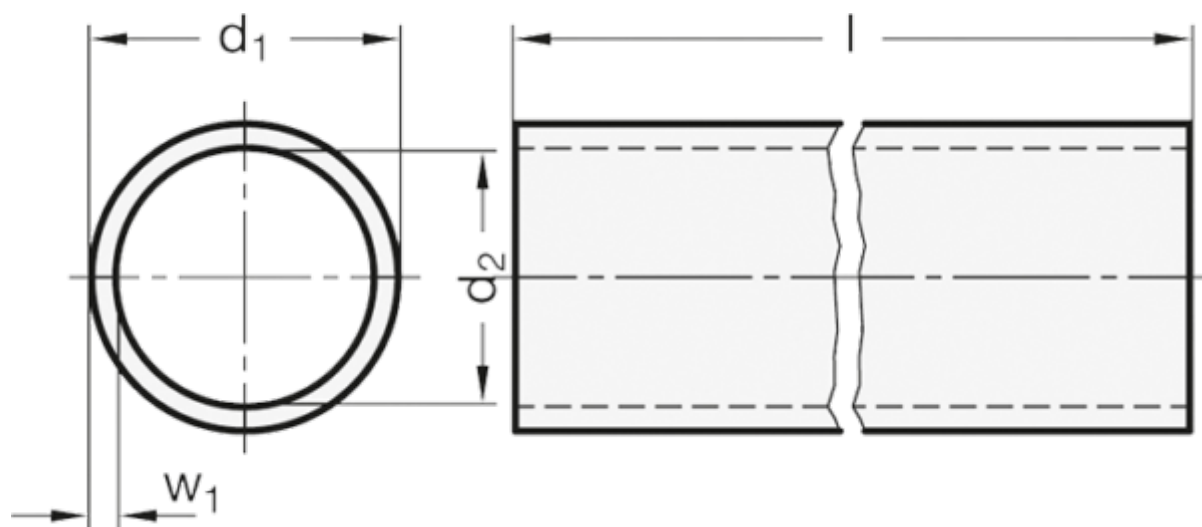

$d_1$  = D15 +0.05/-0.15

$d_2$  = 12

$l \pm 0.5$  = 500

$w_1$  = 1.5

Weight in (g) = 80